

TBI TRANSFORMER BOBBIN INDUSTRIAL CO.,LTD.

Phone 886-2-22929999 Fax 886-2-22925236
E-MAIL: tb6688@ms46.hinet.net

REVISIONS

REV	SYM	DRAFTER	CHECKER	DATE
△		T.S.LII	W.H.HSU	07/14/00
△				
△				

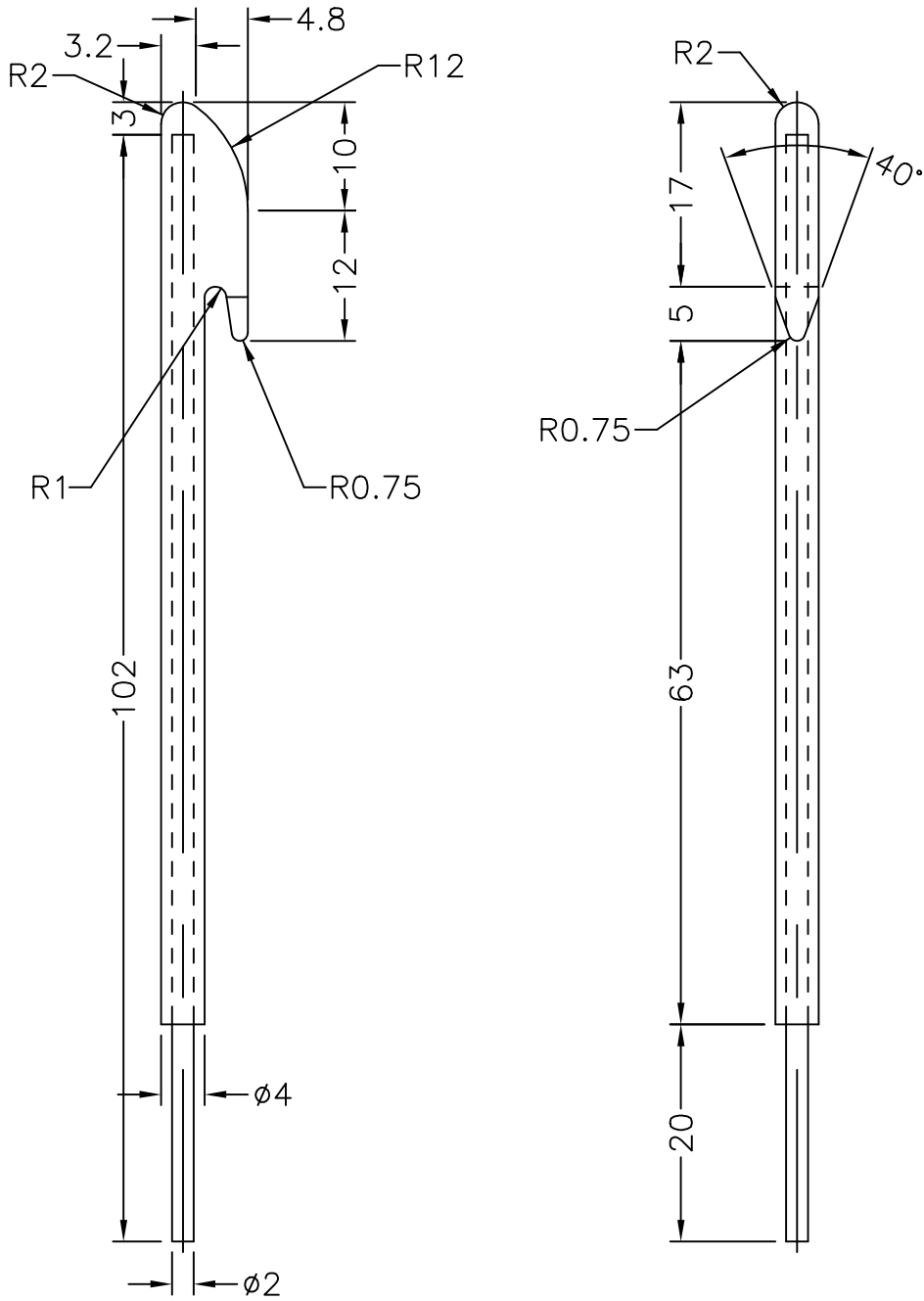

PART NO.	Hand Hook NO.4						
DWG NO.	TBI-521-04011.A0						
TBI NO.	MATERIAL						
521-04011.A0	POM			PART NO.	REV	MODE NO	PIN LOCATION
							TOLERANCE
							.X± .XX±
							UNIT
							m/m
							SCALE
							1.5 : 1
							REV
							1